

MC-E

Installation Instructions & Programming Guide

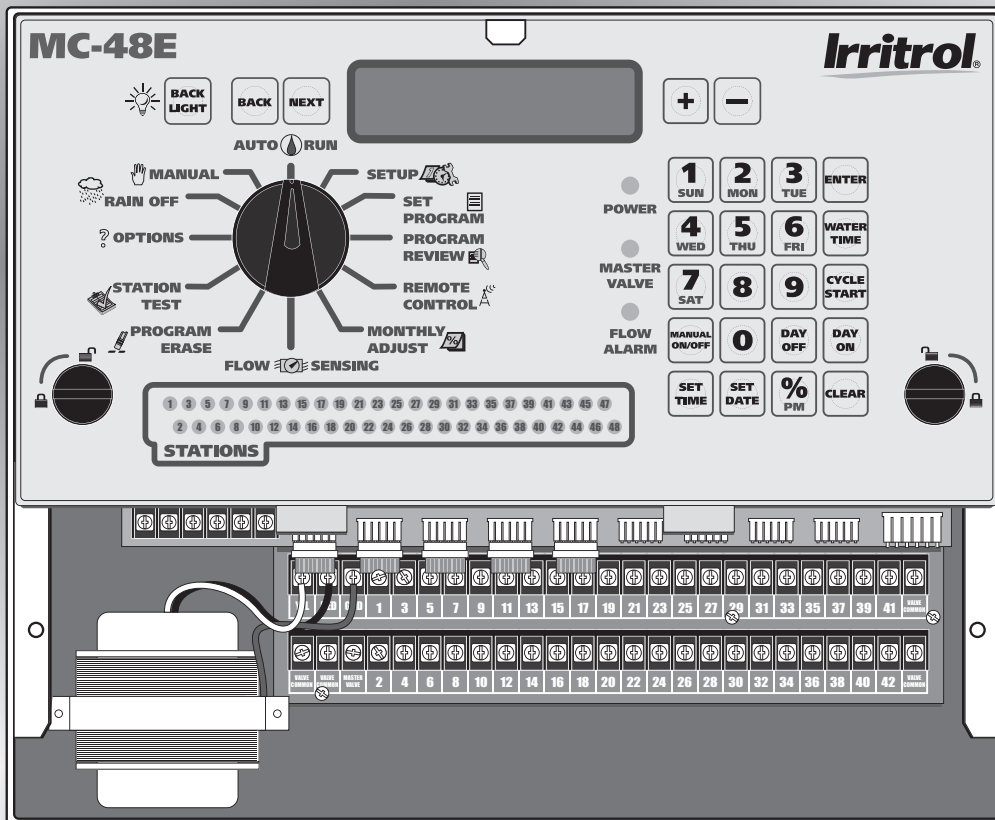

For Controller Models: MC-4E, MC-6E, MC-8E, MC-12E, MC-18E, MC-24E, MC-30E, MC-36E, MC-42E & MC-48E

Irritrol®

English

Español

Français

Table of Contents

Introduction	Pg. 3
Parts Diagram	Pg. 3
Cabinet Installation	Pg. 4
Electrical Conduits Installation	Pg. 4
Control Wires Installation	Pg. 5
Rain Sensor Installation (Purchased Separately)	Pg. 6
Start Sensor Installation (Purchased Separately)	Pg. 6
Power Source Installation	Pg. 7
Circuit Breaker Diagnostic System	Pg. 7
Power On / Reset Mode	Pg. 8
System SETUP	
Current Date	Pg. 8
Current Time	Pg. 9
Security Password	Pg. 10
Event Days	Pg. 11
Set Master Valve	Pg. 12
Program SETUP	
Assign Station & Runtime to a Program	Pgs. 13–14
Program Start Time	Pgs. 15–16
Station Delay Time	Pg. 17
Looping Start Time	Pgs. 18–19
Watering Day Schedule	Pgs. 20–23
Monthly Adjust / Watering Budget	Pgs. 24–25
Program Review	Pg. 26
Program Erase	
Single Program	Pg. 27
Complete Program Reset	Pg. 28
Complete Controller Reset	Pg. 28
Station Test	Pg. 29
Options	
Options 1–8	Pg. 30
Option 9	Pg. 30
Option 10	Pg. 31
Option 11	Pg. 31
Rain Off	Pg. 32
Semi-Auto Operation	Pg. 32
Manual Operation	Pg. 33
Remote Control (Purchased Separately)	Pg. 34
Flow Sensor	Pgs. 35–39
Specifications	Back Cover
Electromagnetic Compatibility	Back Cover

Introduction

Thank you for purchasing the MC-E controller by Irritrol. The MC-E controller is a solid-state irrigation controller, capable of storing eight independent programs designed to meet the needs of commercial and contractor applications. The MC-E is an enhancement to the existing MC controller with many more functions and display features. The new MC-E is designed to be compatible with the previous MC Plus B cabinets and wiring connections.

Parts Diagram

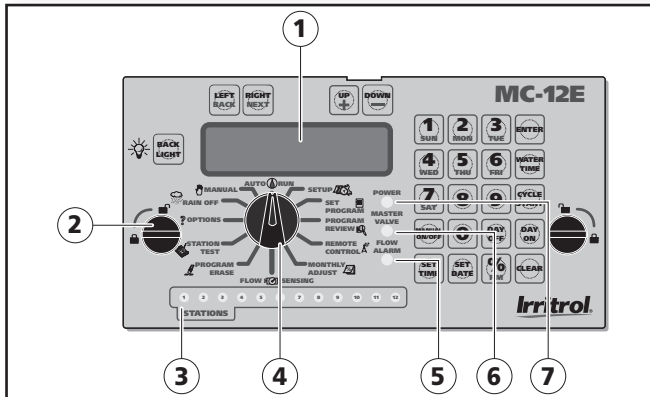

- 1 - 32-Character Dot Matrix LCD
- 2 - Timing Mechanism Quick Release
- 3 - Active Station Indicator Display
- 4 - Function Dial
- 5 - Flow Alarm Indicator LED
- 6 - Master Valve Active Indicator LED
- 7 - Power Supply Indicator LED

BACK LIGHT - Activates the LCD Display Backlight

BACK - Use to navigate through the menu options

NEXT - Use to navigate through the menu options

+ - Use to navigate through the menu selections or options

- - Use to navigate through the menu selections or options

ENTER - Finalize and save entered parameters

WATER TIME - SETUP - Assigns Station and Station Runtime to a program

CYCLE START - SETUP - Assign Start Times to a program

DAY OFF - SETUP - Assign Event Days

DAY ON - SETUP - Remove Event Days

MANUAL ON/OFF - MANUAL - Activate stations or programs manually

SET TIME - SETUP / SET PROGRAM - Modify the current time

SET DATE - SETUP / SET PROGRAM - Modify current date

% PM - MONTHLY ADJUST - Adjust water budget percentage.

CLEAR - Clear / Delete selection / Revert back to the main menu of the current dial position

Cabinet Installation

Step 1 – Selecting the proper installation site for the MC-E controller is essential to safe and reliable operation. The controller features a weather resistant cabinet designed for indoor and outdoor installation. The controller should be installed on a vertical wall or other sturdy structure near a grounded power source. Select a location that provides as much protection from direct sunlight, rain, snow and irrigation spray as possible.

Step 2 – Drive a wood screw (provided) into the wall at eye level.

(For Large Cabinet Unit - 18 Stations or more) Drive another wood screw 8" (20.3 cm) directly below the first screw.

(For Small Cabinet Unit - 12 Stations or less) Drive another wood screw 5 3/4" (14.5 cm) directly below the first screw.

Leave approximately 1/4" (6.5 mm) of the screw extended from the wall to accommodate the cabinet.

NOTE: For drywall and masonry installation, use proper screw anchors to prevent the screws from loosening.

Step 3 – Place the controller cabinet on the screws using the keyhole slots on the back panel. Ensure that the cabinet is installed securely on the screws. See **Figure 1**.

Step 4 – Open the controller door and remove the bottom panel door. Locate the bottom screw and tighten it securely.

The MC-E series has two available lockable, weather and vandal resistant steel pedestals for free standing applications. For MC-E controllers with 12 stations or less, use the Irritrol P-2B pedestal. For MC-E controllers with 18 stations or more, use the Irritrol P-6B pedestal. Follow the installation and mounting instructions that are provided with the pedestal.

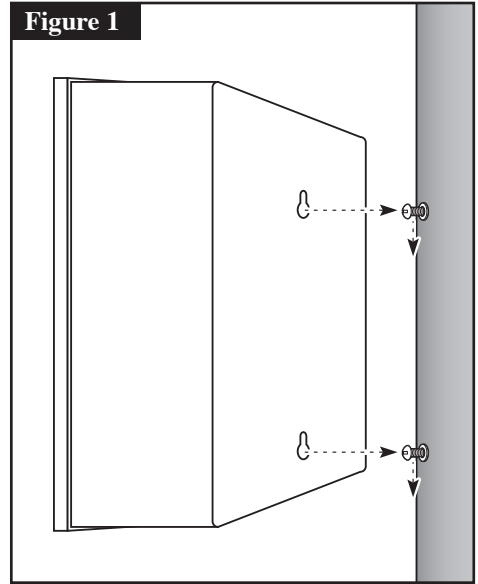

Electrical Conduit Installation

Electrical conduit and adapters are not supplied with the controller but may be required for installations in your area. Check with your local electrical codes and install conduit according to requirements.

For power wires, install a 1/2" (13 mm) NPT threaded conduit access body to the transformer assembly threaded nipple. From the access body, install conduit to the power source.

For station valve wiring, install a 2" (5 cm) conduit adapter and conduit.

Control Wires Installation

Step 1 – Route the valve control wires between the valves and the MC-E controller.

NOTE: For wire runs up to 1000' between the controller and the valves, it is recommended to use an 18 AWG (1.0 mm²) multi-wire sprinkler valve connection cable. This cable is insulated for direct burial and is color coded to simplify installation.

Step 2 – Attach one wire from each valve solenoid to the white color-coded wire from the cable. (Since the valve solenoid has no polarity, either wire can be used for this connection.) Designate this connection as the Valve Common.

Step 3 – Attach a separate cable wire to each of the remaining valve solenoid wire. Take note of the wire color being used for each valve as well as the watering zone/area it is designated. This information will be important when connecting the valve wires to the controller's station terminals.

Step 4 – Use wire nut fasteners to secure the valve solenoid wire connection. Waterproof all connections with grease caps or similar insulation method.

Step 5 – Route the other end of the control wires into the provided conduit hole at the bottom of the cabinet. Leave about 8" of cable remaining in the cabinet. Expose about 3/8" of bare wire from the station and the valve common wires.

Step 6 – Secure the valve common wire to one of the three terminals labeled "VALVE COMMON" and each valve wire to its appropriate station terminal designation.

* **NOTE:** For flow monitoring, with a flow sensor installed, Station #2 is programmed and used as activation circuit for a normally-open master valve instead of a regular station valve. (See page 36 "Install Critical Flow Shut Off Master Valve".)

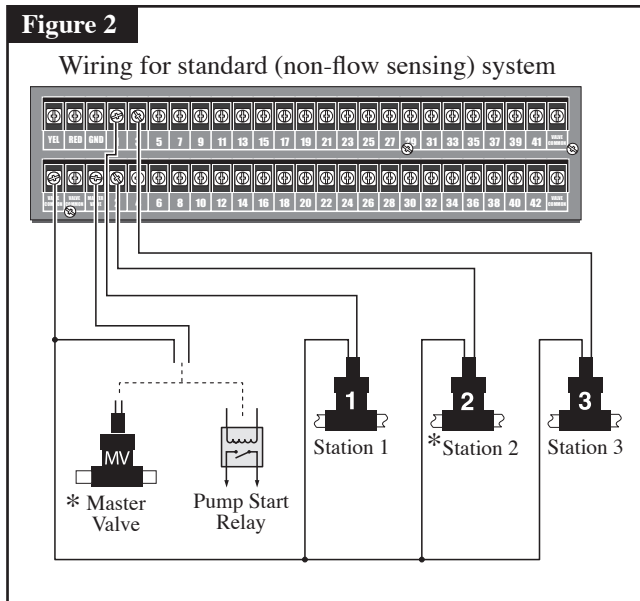

Rain Sensor Installation (Purchased Separately)

IMPORTANT! The INHIBIT SENSOR is designed for a normally closed rain sensor. The wire jumper must be present at the terminals if a sensor is not connected.

- Step 1 – Route the rain sensor cable into the controller terminals.
- Step 2 – Remove the wire jumper from the INHIBIT and SENSOR terminals for the 18 stations or more models and INHIB.SEN and SEN.COM for the 12 stations or less models. Refer to the provided rain sensor installation guide for wiring instructions and connect accordingly.

NOTE: The INHIBIT SENSOR will operate on any Function Dial position settings.

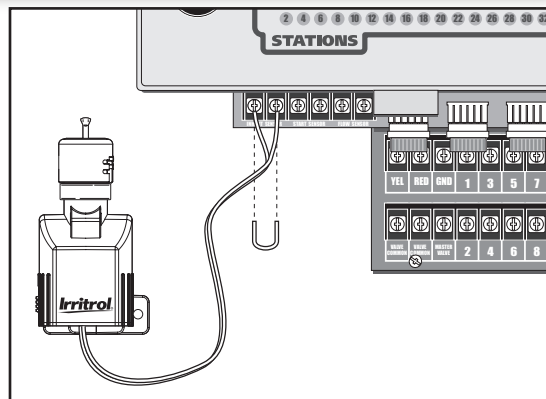

Start Sensor Installation (Purchased Separately)

IMPORTANT! The START SENSOR input is designed for a normally open sensor and works in conjunction with Options 9 and 10. When the start sensor is activated, the MC-E controller will immediately activate Program 1 providing Option 10 is activated. Program 1 will continue to repeat the cycle until the start sensor is deactivated. The activation of the start sensor will not affect any other programs. Option 9 works similarly by turning ON program 8, however all other programs are turned OFF.

- Step 1 – Route the sensor connection cable through the bottom of the controller cabinet and into the controller terminals.
- Step 2 – Refer to the provided sensor installation guide for wiring instructions.

NOTE: The START SENSOR will operate on any Function Dial position except for RAIN OFF.

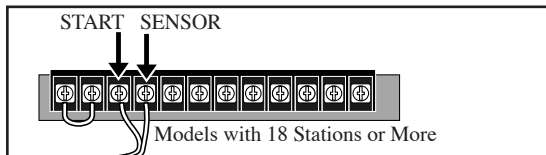
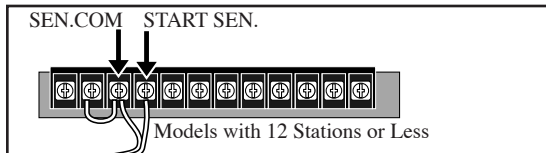
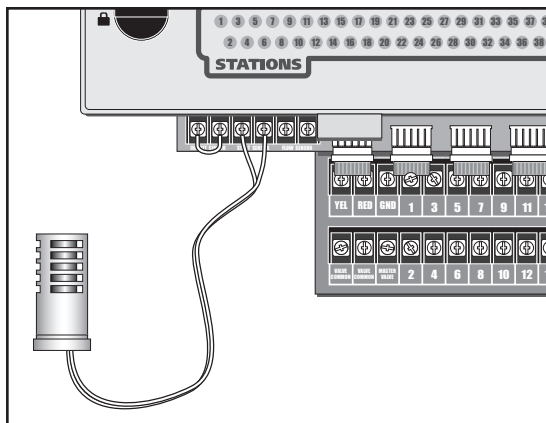

Power Source Installation

⚠ WARNING: All electrical components and installation practices must meet applicable national and local electrical codes including installation by a qualified personnel. These codes may require an external junction box mounted on the cabinet and a circuit breaker in the main wiring having a contact separation of at least 0.120" in the line and neutral poles.

The 120 VAC power source must be turned OFF prior to servicing. The power cable used for connection to the controller must have an insulation rating of 221° F minimum.

- Step 1 – For power source connection, install a 1/2" electrical conduit from the 120 VAC power source to the MC-E controller cabinet.
- Step 2 – Install an electrical junction box at the transformer to allow access for future servicing.
- Step 3 – Confirm that power has been disconnected at the power source using a volt meter or voltage detector.
- Step 4 – Route 14-AWG insulated solid copper wires for Power (Black), Neutral (White) and Equipment Ground (Green) through the conduit and into the junction box.
- Step 5 – Strip back 3/8" of insulation from each wire. Using wire connectors, connect the wires with similar colors together (Black with Black, White with White, etc.).
- Step 6 – Tuck the wires inside the junction box and replace the cover.
- Step 7 – Apply power to the controller.

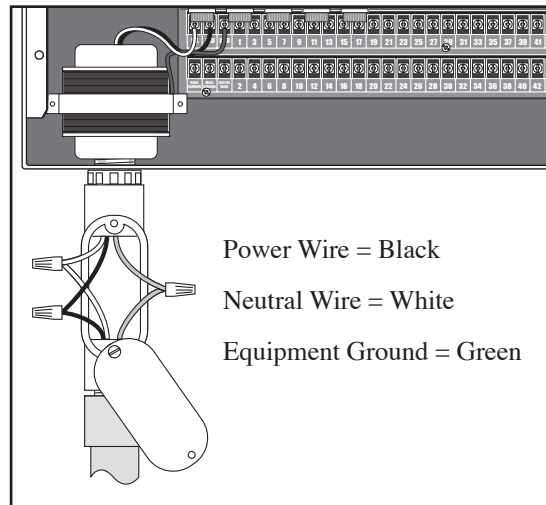

Circuit Breaker Diagnostic System

The controller's system for managing an electrical short circuit is designed to isolate the station with the problem and continue to water operable stations. The sequence the controller follows is listed below.

1. The controller reaches a station with a short circuit.
2. The controller shuts off the problem station and skips to the next station in the same program and continues operation.
3. The controller displays "Fuse Alarm on ___" and the problem station's number as well as the other station in operation.
4. In between programs, when the controller is idle, it will display the Fuse Alarm station alternating with the display of Day/Date/Time.
5. The next time the controller is supposed to run the station, it will try again. If the cause of the short has been repaired, the Fuse Alarm will disappear from the display and the station will run normally. You can also use the CLEAR button to clear the Fuse Alarm from the display. This does not fix the shorted circuit, but only clears its display.

NOTE: The controller has fractions of a second to detect and shutoff the problem station before the short circuit causes damage. On occasion, with multiple programs and stations running, the controller shuts off and displays two stations as having shorts. You can test each station in MANUAL mode or with STATION TEST to find the shorted one.

Power On / Reset Mode

MC-E will initiate the operating system and reload all saved data in the memory for stable operation every time the controller is powered up. Place the Function Dial in the Auto/Run position for normal operation.

Initial Display

```
IRRITROL MC_48E
Loading.....
```

Auto Run Mode Display

```
FRI 02-24-2006
10:21:03 AM
```

System SETUP

The SETUP  function allows you to modify the following MC-E parameters:

```
Press SETTIME,
SETDATE or NEXT
```

- Current Date
- Current Time
- Security Password
- Event Days
- Enable/Disable Master Valve

SETUP – Current Date

Set Current Date

Step 1 – Place the Function dial to the SETUP  position.

Step 2 – Set the date mode if necessary. To set the date to International format (Day/Month/Year), press **0** .
To return to the default U.S. format, press **1**  .

NOTE: Press the  button to clear any “Key Entry Error”.

Step 3 – Press the  or the  button to access the date setup screen.

Step 4 – Enter the Month, Date and Year in **MM DD YY** format. If the MC-E is operating in International format, enter the Date first, the Month second and the year last (**DD MM YY**).

Example: For February 20, 2006, press the **022006** buttons.

```
SET MM DD YY
DATE ■ - - U.S. format
```

```
SET DD MM YY
DATE ■ - - International format
```

Step 5 – Press the  button to accept the changes. The display will now reflect the new date.

```
MON 02-20-2006
1:21:03 PM U.S. format
```

```
MON 20-02-2006
13:21:03 International format
```





NOTE: While in SET DATE mode, you can advance to the SET TIME mode by pressing the NEXT  button.

Step 6 – Return the Function dial to AUTO/RUN  position to exit SETUP.

SETUP – Current Time

Set Current Time

Step 1 – Place the Function Dial to the SETUP  position.

Step 2 – Set the time mode if necessary. To set the time to International format (24-hour), press  .
To return to the default U.S. format, press  .

NOTE: Press the  button to clear any “Key Entry Error”.

Step 3 – Press  or press the  button until the time setup screen is displayed.

SET HH MM AM/PM
TIME ■ : AM

U.S. format

SET HH MM
TIME ■ :

International format

Step 4 – Enter the Hour, Minutes and Seconds in **H MM** format. Enter the **H MM**  for PM time.
International setting follows the 24-hour format.

Example: For 10:30am, enter **1030**.



Step 5 – Press the  button to accept the changes. The display will now reflect the new time.

MON 02-20-2006
10:30:03 AM

U.S. format

MON 20-02-2006
10:30:03

International format

NOTE: While in SET TIME mode, you can advance to the SET LANGUAGE screen by pressing the  button or go back to SET DATE by pressing the  button.

Step 6 – Return the Function dial to AUTO/RUN  position to exit SETUP.

SETUP – Security Password

The MC-E can be secured with a security password to ensure that unauthorized users are not able to modify the programs.

Enable Security Password

Step 1 – Place the Function Dial to the SETUP  position.



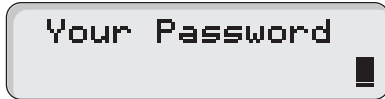

Step 2 – Press the  button. The screen will display the following:



Step 3 – Enter a four-digit (0000–9999) security password and press the  button.

NOTE: Once a security password is established, all menu functions will require you to enter the four-digit security password before gaining access. However, manual operations are allowed.

Once the security password is verified, the MC-E will allow access to the menu functions for one hour. Within that hour, you will be able to navigate through all the function dial positions without re-entering the security password. After the 1-hour time limit expires, you will need to re-enter the password to gain access to the menu functions.

In the event that you have forgotten the four-digit security password, press , ,  and  to disable the password verification process. To reestablish password security to the controller, you must repeat Steps 1–3.

NOTE: Press the  button to clear any “Key Entry Error”.

Step 4 – Return the Function dial to AUTO/RUN  position to exit SETUP.

SETUP – Event Days

The MC-E allows you to pre-program ten event days throughout the year. During an event day, the controller will suspend automatic watering. Event days will reoccur every year unless deleted.

Example: If July 4th is set as an event day, the controller will ignore watering every July 4th of each year until it is deleted from the Event Days.

Set Event Day:

Step 1 – Place the Function Dial to the SETUP  position.

Step 2 – Press the  button. The screen will display the following:



0 EVENT DAY SET
PRESS DAYOFF █

Press the  button to review the day off events or enter new events. The screen will display the following:



SET EVENT MM DD
EVENT# 1 █0/0

NOTE: Use the  or  button to review the programmed events. Press the  button to clear any “Key Entry Error”.

Step 3 – Enter the Event number (1–10), then press the  button.





NOTE: MC-E will re-number the event day if the newly created event is deleted.

Step 4 – Enter the Month and Date (MM DD) of the event day being programmed and press the  button. When the controller is in International mode, enter the Date first before the Month (DD MM). The controller will increment the total event day and display the following:



1 EVENT DAY SET
PRESS DAYOFF █

Step 5 – Repeat Steps 2–3 for additional event days.

Step 6 – To delete an event, scroll through the event number to select it. Once the event is displayed, enter     and press the  button to delete.

Step 7 – Return the Function dial to AUTO/RUN  position to exit SETUP.

SETUP – Master Valve

Set Master Valve

NOTE: As factory default, the Master valve is Enabled for all stations. The master valve will activate whenever a station is activated.

NOTE: If flow sensing is to be activated, all stations must be set to “MV=ON”.





In situations that a station does not require the master valve to activate, use the following procedure to select the station and Disable or Enable the master valve.

Step 1 – Place the Function Dial to the SETUP  position.

Step 2 – Press the  button. The following display will be shown on the screen.



MV SET UP
STN 1 MV=ON

Step 3 – Press the  or  buttons to select the station number you want to edit. Use the  or  button to toggle MV (Master Valve) from ON or OFF.

NOTE: Press the  button to clear any “Key Entry Error”.

Step 4 – Repeat Step 3 for additional stations.

Step 5 – Return the Function dial to AUTO/RUN  position to exit SETUP.

Program SETUP

For a watering program to operate properly, it must have a station(s) with a runtime and a specific date and time to activate. The following program parameters can be defined and/or modified in the SET PROGRAM  function:

- Assign Station and Runtime to a Program
- Assign Station Delay Time
- Assign Program Start Time
- Assign Looping Start Time
- Assign Water Budget
- Assign Watering Day Schedule
 - Exclusion Day
 - Odd Day
 - Even Day
 - Interval Day

Set Program – Assign Station and Runtime to a Program

Assign Station and Runtime to a Program

Step 1 – Place the Function Dial to the SET PROGRAM  position.

```
Enter PROGRAM#  
& Press ENTER
```





Step 2 – Enter the program number (1–8) you want to create or modify. Press  to activate your selection.

Step 3 – Enter the station number being added or modified in the program and press the  button.

NOTE: Entering a station number that exceeds the controller’s station count will return an error message.







Press the  button to clear any “Key Entry Error”.

```
PROGRAM 1  
STN 1 No Runtime
```

Step 4 – Enter the station runtime in MM (Minutes), H MM (Hours:Minutes) or 0:SS (0:Seconds [10 seconds minimum]) and press . To enter a station runtime in seconds, enter “0” first before entering the number of seconds. For example, to enter 30 seconds of runtime you must press   .

```
PROGRAM 1  
STN 1 0h30m 0s
```

Repeat Steps 3–4 for additional stations and runtimes.

To assign similar runtimes to a group of stations, go to Step 2. After entering the program number (1–8) and pressing , press   and press . Then enter the two-digit station number of the lowest station and the two-digit station number of the highest station in the group (i.e. 0912 will designate stations 9 through 12 in the group) and press  again. Enter the length of runtime, then press . This procedure will replace all station runtimes in the group with the new runtime.

NOTE: Enter a runtime value of 0 minutes to delete.

Step 5 – Return the Function dial to AUTO/RUN  position to exit SET PROGRAM.

Enter/Modify/Delete - Single or Multiple Stations

Step 1 – Place the Function Dial to the SET PROGRAM  position.

Enter PROGRAM#
& Press ENTER

Step 2 – Enter the program number (1–8) being modified. Press  to activate the selection.

NOTE: Press the  button to clear any “Key Entry Error”.

Step 3 – Enter the station number you want to create, modify or delete from the program and press the  button.

Select multiple stations by entering the first station number (two digits), then enter the last station in the sequence (two digits) and press the  button.

NOTE: Entering a station number that is not assigned to the program will return a “No Runtime” message.

Step 4 – Assign the station runtime and press the  button. If the station has a previous runtime, the newly entered runtime will overwrite the previous value. Enter a runtime value of 0 minutes to delete.

Step 5 – Repeat Steps 3–4 to enter/modify/delete additional station(s) from the program.

Step 6 – Return the Function dial to AUTO/RUN  position to exit SET PROGRAM.

Review Program Runtimes

Step 1 – Place the Function Dial to the SET PROGRAM  position.

Step 2 – Enter the program number (1–8) being modified. Press  to activate the selection.

NOTE: Press the  button to clear any “Key Entry Error”.

Step 3 – Press the  button once to review the program’s cumulative runtime.

Press the  button twice to review individual station’s runtime in the program. The controller will sequentially scroll through the program’s active stations along with their corresponding runtime.

Step 4 – Return the Function dial to AUTO/RUN  position.



Set Program – Program Start Time



Set Program Start Times

Each MC-E program can have up to eight start times. Programs can start at anytime except midnight.

Step 1 – Place the Function Dial to the SET PROGRAM  position.

Step 2 – Enter the program number (1–8) being modified. Press  to activate the selection.

NOTE: Press the  button to review all start times. Each programmed start times will be displayed momentarily until the last start time is shown. Press the  button to clear any “Key Entry Error”.

Step 3 – Enter the start time number (1–8) being created/modified and press the  button. Enter the start time in **H MM** (Hours and Minutes) and press .

NOTE: Enter H MM  for PM time. (U.S. Time Mode)

The start time number will adjust according to the start time sequence. If assigning start time 4 with 6:00am and currently, the earliest start time is at 7:30am, 6:00am will automatically become start time number 1 and adjust the start time numbers according to the overall runtime for that program.

Example: Assign 5:30am to start time number 1 for program 1 by entering **0530** .

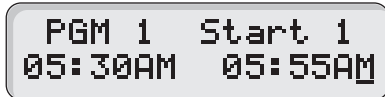

FGM 1 Start 1
05:30AM 05:55AM

NOTE: The 05:55am time indicated on the display is the end time. This is calculated by adding the sum of all the station runtimes and station delays to the start time.

If the assigned start time will result with an end time past midnight, the controller will emit a long beep to indicate that end time will run to the next watering day schedule. An asterisk (*) next to the end time also indicate that the displayed end time is effective past midnight.

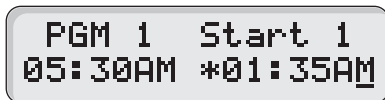



FGM 1 Start 1
05:30AM *01:35AM

Step 4 – Return the Function dial to AUTO/RUN  position to exit SET PROGRAM.

NOTE: If setting a start time causes an overlap through midnight (day changeover), you will hear two long beeps and see an asterisk in the display to alert you of the situation. The controller will complete the cycle that initiates before midnight and completes it even after midnight. However, any subsequent start times in the same program that were pushed into the next day will be lost. Check your start times and adjust accordingly. Do not use midnight as a start time.



Delete Program Start Time

Step 1 – Place the Function Dial to the SET PROGRAM  position.

Step 2 – Enter the program number (1–8) being modified. Press the  to activate the selection.

NOTE: Press the  button to clear any “Key Entry Error”.

Step 3 – Press the  button to review all start times. Each programmed start times will be displayed momentarily until the last start time is shown.

Step 4 – Enter the start time number (1–8) being deleted and press the  button. Assign a start time of 0 and press  to finalize.



PROGRAM 1
Start 1 Erased.

NOTE: After deleting a Start, MC-E will renumber remaining the start times to fill the empty start time slot. i.e., After deleting start time 1, start time 2 will fill in start time 1 slot and so on.

Step 5 – Return the Function dial to AUTO/RUN  position to exit SET PROGRAM.

Step 6 – Repeat Steps 1–5 to delete additional start times.

Set Program – Station Delay Time

Station delay time is the adjustable delay period between station operations. The controller's default station delay is 0 seconds. The maximum delay time you can set between station operation is 4 hours.

Assign Station Delay Time

Step 1 – Place the Function Dial to the SET PROGRAM  position.

Step 2 – Enter the program number (1–8) being modified. Press the  to activate the selection.

NOTE: Press the  button to clear any “Key Entry Error”.

Step 3 – Press the  and  buttons to access the station delay function.



PROGRAM 1
01ySTN 0h 0m 0s

Step 4 – Enter the station delay duration in H MM SS (Hours, Minutes and Seconds) and press .

NOTE: To disable the station delay, assign 0 for the time duration.

Example: To assign a 30-second station delay to program 1, enter 0 00 30.



PROGRAM 1
01ySTN 0h 0m30s

Step 5 – Return the Function dial to AUTO/RUN  position to exit SET PROGRAM.

Set Program – Looping Start Time

The MC-E has the capability to loop a program. When a program is set to loop, the program will repeat after the loop delay time is satisfied. The program will continue to repeat beginning from the start time until the designated end time. To initiate the program to loop, you must assign a start time, end time and a loop delay to the program.

Set a Looping Start Time

Step 1 – Establish a start time to the program. (See **Set Program – Program Start Time** section.)

Step 2 – Assign a program End time. Place the Function Dial to the SET PROGRAM  position. Enter the program number being modified. Enter **8** **8**  to access the loop function.

NOTE: Press the  button to clear any “Key Entry Error”.

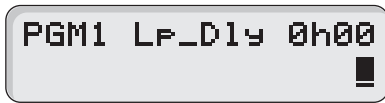

PGM1 LF_D1y 0h00

Enter the program end time in **H MM** format and press . Use the  button for PM.

Example: Enter 6:00am start time and 10:00pm end time.

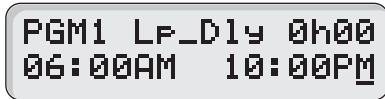

PGM1 LF_D1y 0h00
06:00AM 10:00PM

Step 3 – You must assign a loop delay by entering **8** **8** . Enter the delay time in **H MM** or **MM** and press .

Example: Assign a 30-minute loop delay. Enter **3** **0** .

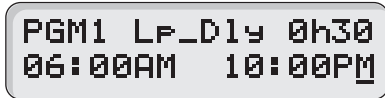

PGM1 LF_D1y 0h30
06:00AM 10:00PM

NOTE: After establishing a loop, any additional program start time(s) will be deleted.

Step 4 – Return the Function dial to AUTO/RUN  position to exit SET PROGRAM.





 **IMPORTANT!** A looping program must have its start time and end time programmed to occur on the same day. Looping through midnight (end time is on another day) may cause the end time to be ignored or lost.





Modify a Looping Start Time





Step 1 – Place the Function Dial to the SET PROGRAM  position.

Step 2 – Enter the program number (1–8) being modified. Press the  to activate the selection.

NOTE: Press the  button to clear any “Key Entry Error”.

Step 3 – Press   to enter a new loop start time in H MM format (Hours, Minutes and  for PM) and press  to accept.

Step 4 – Press    to enter a new loop end time in H MM format (Hours, Minutes and  for PM) and press  to accept.

Step 5 – Press    to enter a new loop delay time in H MM format (Hours, Minutes) and press  to accept.





Step 6 – Return the Function dial to AUTO/RUN  position to exit SET PROGRAM.

Delete a Looping Start Time

Step 1 – Place the Function Dial to the SET PROGRAM  position.

Step 2 – Enter the program number (1–8) being modified. Press the  to activate the selection.

NOTE: Press the  button to clear any “Key Entry Error”.

Step 3 – Enter     and press  to clear the looping start time. (The start time and end time are automatically deleted.)



PROGRAM 1
Loop Erased.....

Step 4 –  activate the program. (See **Set Program – Program Start Time** section.)

Step 5 – Return the Function dial to AUTO/RUN  position to exit SET PROGRAM.

Set Program – Watering Day Schedule

The MC-E offers you several options to schedule your watering programs. Having multiple options will allow you to optimize your watering need while practicing water conservation.

Each of the eight controller programs can be set to one of the following schedule options:





- Days of the Week / Exclusion Days
- Odd Days Watering w/ Exclusion Days
- Even Days Watering w/ Exclusion Days
- Skip Days

Set Program Schedule to Days of the Week / Exclusion Days

Step 1 – Place the Function Dial to the SET PROGRAM  position.

Step 2 – Enter the program number (1–8) being modified. Press the  to activate the selection.





NOTE: Press the  button to clear any “Key Entry Error”.

Step 3 – Press the  button to review the program schedule. The Weekdays scheduling is the factory default. If Odd or Even scheduling is activated, press    to reestablish Weekdays scheduling.



PGM 1 WeekDaysOn
SuMoTuWeThFrSa

Step 4 – To exclude a day, enter the day designation number and press the  button.
Su = 1, Mo = 2, Tu = 3, We = 4, Th = 5, Fr = 6 and Sa = 7

Example: Deactivate Sunday (Su) and Wednesday (We) to the Weekdays schedule. Press   to deactivate Sunday and   buttons to deactivate Wednesday.



PGM 1 WeekDaysOn
MoTu ThFrSa

The remaining days, Monday, Tuesday, Thursday, Friday and Saturday are all active days. The program will run only on these days.

NOTE: To deactivate all the days of the week, press   .

Step 5 – To re-activate a day, enter the day designation number and press the  button.

Step 6 – Return the Function dial to AUTO/RUN  position to exit SET PROGRAM.

Odd Days watering schedule will activate the program on the odd-numbered days in the calendar month (1, 3, 5, ..., 29).

Set Program Schedule to Odd Days

Step 1 – Place the Function Dial to the SET PROGRAM  position.

Step 2 – Enter the program number (1–8) being modified. Press the  to activate the selection.

NOTE: Press the  button to clear any “Key Entry Error”.

Step 3 – Press the    button to activate Odd days watering schedule.



PGM 1 OddDaysOn
No ExclusionDays

Step 4 – Return the Function dial to AUTO/RUN  position to exit SET PROGRAM.

In conjunction to setting your irrigation schedule to Odd Days of the calendar schedule, you can also deactivate any day of the week.





Set Program Schedule to Odd Days with Excluded Days

Step 1 – Set watering schedule to Odd days. (See section “Set Program Schedule to Odd Days”.)





PGM 1 OddDaysOn
No ExclusionDays

Step 2 – To exclude a day, enter the day designation number and press the  button.
Su = 1, Mo = 2, Tu = 3, We = 4, Th = 5, Fr = 6 and Sa = 7

Example: Deactivate Wednesday (We) and Saturday (Sa) to the Weekdays schedule. Press   to deactivate Wednesday and   buttons to deactivate Saturday.



PGM 1 OddDaysOn
SuMoTu ThFr ■

NOTE: To return the program’s scheduling to Weekdays, press the    buttons.

Step 4 – Return the Function dial to AUTO/RUN  position to exit SET PROGRAM.



Even Days watering schedule will activate the program on the Even-numbered days in the calendar month (2, 4, 6, ..., 30).

Set Program Schedule to Even Days

Step 1 – Place the Function Dial to the SET PROGRAM  position.

Step 2 – Enter the program number (1–8) being modified. Press the  to activate the selection.

NOTE: Press the  button to clear any “Key Entry Error”.

Step 3 – Press the    button to activate Even days watering schedule.



PGM 1 EvenDaysOn
No ExclusionDays

Step 4 – Return the Function dial to AUTO/RUN  position to exit SET PROGRAM.

In conjunction to setting your irrigation schedule to Even Days of the calendar schedule, you can also deactivate any day of the week.





Set Program Schedule to Even Days with Excluded Days

Step 1 – Set watering schedule to Even days. (See section “Set Program Schedule to Even Days”.)





PGM 1 EvenDaysOn
No ExclusionDays

Step 2 – To exclude a day, enter the day designation number and press the  button.
Su = 1, Mo = 2, Tu = 3, We = 4, Th = 5, Fr = 6 and Sa = 7

Example: Deactivate Sundays (Su) and Fridays (Fr) to the Weekdays schedule. Press   to deactivate Sundays and   buttons to deactivate Fridays.



PGM 1 EvenDaysOn
MoTuWeTh Sa

NOTE: To return the program’s scheduling to Weekdays, press the    buttons.

Step 4 – Return the Function dial to AUTO/RUN  position to exit SET PROGRAM.

Skip Days watering schedule will activate the program within the specified interval. You can designate skip days from 1 through 59 days between watering days. The entered value will be the number of days the controller will skip until an active watering day. If you enter a value of 3, MC-E skip watering for 3 consecutive days and water on the fourth day. MC-E will repeat the schedule after the active day.

Set Skip Days Program Schedule

Step 1 – Place the Function Dial to the SET PROGRAM  position.

Step 2 – Enter the program number (1–8) being modified. Press the  to activate the selection.



NOTE: Press the  button to clear any “Key Entry Error”.

Step 3 – Press the    button to activate Skip days watering schedule. Default settings are “0” days and “0” skips.



```
PGM 1 SkipDaysOn
0 Days Today= 0
```



Step 4 – Enter the designated Skip day number and press the  button. (1 = skip 1 day then water the next day, 2 = skip 2 days then water the next day, etc.)

Example: Set the program to skip 4 days before activating. Press   .







```
PGM 1 SkipDaysOn
4 Days Today= 0
```

Step 5 – Enter today’s designation number and press the  button. This number represents the current day’s position within the schedule interval. This number will increment on a daily basis starting from 0 (zero) until the skip day number designation is met. When the skip day number and the “Today” number are equal, then the controller will regard that day as the program’s watering day.

Example: With skip day set to 4, the program is set to skip days 0, 1, 2 and 3. Set today so that the controller will water the next day. Enter   and press the  button.



```
PGM 1 SkipDaysOn
4 Days Today= 3
```

NOTE: To return the program’s scheduling to Weekdays, press the     buttons.



Step 6 – Return the Function dial to AUTO/RUN  position to exit SET PROGRAM.



Monthly Adjust / Water Budget

The MC-E water budget  feature maximizes water conservation by allowing you to micro-adjust watering on a monthly basis. By adjusting your irrigation during dry seasons, wet seasons, etc., you can be sure that your landscape areas are receiving the optimum irrigation while conserving water resource.



Adjust the Monthly Water Budget

Step 1 – Place the Function Dial to the MONTHLY ADJUST  position.





NOTE: To review all monthly adjustments, simply press the  button twice while in the MONTHLY ADJUST  position. Each monthly percent budget will display momentarily.

Step 2 – Use the  or  buttons to scroll and select the month being adjusted. You can also enter the Month's designation number and press the  button to select a specific month.

NOTE: Press the  button to clear any “Key Entry Error”.

Example: Select December to adjust. Press   .



Step 3 – Use the  or  buttons to adjust the watering percentage. The  or  buttons will increment/decrement the percentage by 10%. Press  to save any changes.

In addition, you can adjust the percentage by entering the percentage number using the key pad and pressing the  button to accept.

Example: Adjust December's watering to 85%. Press   .

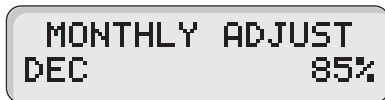

NOTE: You can adjust the monthly watering budget % to 0% (OFF) and up to 200%.

Step 4 – Repeat Steps 2 and 3 to adjust additional monthly water budget.

Step 5 – Return the Function dial to AUTO/RUN  position to exit MONTHLY ADJUST.

CAUTION: Increasing either the program water budget or the monthly water budget percentage may shift station operations to past midnight. During start time review, an asterisk will be displayed alerting you to the situation. The controller will complete programs that start before midnight and end after midnight. However, program start times that have been shifted past midnight (after day change) may be lost. Check your start times and adjust accordingly.

Set Water Budget per Program

Step 1 – Place the Function Dial to the SET PROGRAM  position.

Step 2 – Enter the program number (1–8) being modified. Press the  to activate the selection.





NOTE: Press the  button to clear any “Key Entry Error”.

Step 3 – Press the  button.



PROGRAM 1
Water Budget=100

Step 4 – Enter the desired water budget percentage for the selected program. You can decrease the program’s watering to 0% (no watering) or increase it up to 200%. Press the  button to accept the water budget modification.

Example: Increase Program 1’s watering budget to 150%. Press the  button and enter    to set budget at 150%. Press  to accept.



PROGRAM 1
Water Budget=150

Step 5 – Repeat steps 2–4 to modify additional program water budgets.

NOTE: The Monthly percent adjustment and the water budget percentage will multiply together to get the net increase or decrease of the watering cycle.

Example: Station 1 of Program 1 has a normal runtime of 5 minutes. If the program water budget is set at 200% then the adjusted run time will be 10 minutes (5 min X 2 = 10 min). If the Monthly Adjustment is also set at 200% for the current month, then the adjusted run time will be 20 minutes (5 min X 2 X 2 = 20 min).

Step 6 – Return the Function dial to AUTO/RUN  position to exit SET PROGRAM.

CAUTION: Increasing either the program water budget or the monthly water budget percentage may shift station operations to past midnight. During start time review, an asterisk will be displayed alerting you to the situation. The controller will complete programs that start before midnight and end after midnight. However, program start times that have been shifted past midnight (after day change) may be lost. Check your start times and adjust accordingly.

Program Review

Use this function to review program parameters. Parameter modification is not allowed while in review mode.



Review the Program's Parameters



Step 1 – Place the Function Dial to the Program Review  position.

Step 2 – Enter the program number being reviewed.

NOTE: Press the  button to clear any “Key Entry Error”.

Step 3 – Press the following buttons in the order below to review the parameters:

 - Review the stations and the corresponding runtimes that are assigned to the selected program. When pressed twice, MC-E will sequentially display all activated stations and their runtimes. To review individual stations, enter the station number and press the  button.

 - Review all assigned start times in the program. When pressed, the MC-E will sequentially display all start times beginning from the earliest. Review a specific start time by entering the start time number and pressing the  button.

 - Review the program schedule.

 - Review the program's water budget.

Step 4 – Return the Function dial to AUTO/RUN  position to exit Program Review.

Program Erase – Single Program

Erase Single Program

Step 1 – Place the Function Dial to the Program Erase  position.

```
PROGRAM Erase  
Enter Prog #
```

Step 2 – Enter the program number being erased and press  to process.

NOTE: Press the  button to clear any “Key Entry Error”.

Example: Erase program 8 by pressing the   buttons.

```
PROGRAM Erase  
Erase PGM#8 . . . . .
```

Step 3 – After the deletion, the display will show the following.

```
PROGRAM ERASE  
P1P2P3P4P5P6P7
```

Repeat Step 2 to delete additional programs.

NOTE: Erasing a program will revert it back to default. Program default will have no station and runtime assigned but it will have all **Days of the Week** (Sunday through Saturday) active.

Step 4 – Return the Function dial to AUTO/RUN  position to exit Program Erase.

Program Erase – Complete Program Reset

Activating this function will erase all saved irrigation programs in the MC-E controller. However, it will not erase the current time, date or any **Option** or **SETUP** settings.

Reset All Programs

Step 1 – Place the Function Dial to the Program Erase  position.

PROGRAM Erase
Enter Prog #

Step 2 – Enter **1** **3** **7** **9** and press **ENTER**.

Erase PGM 1 to 8
ARE YOU SERIOUS?

NOTE: Press the **CLEAR** button to clear any “Key Entry Error”.

Press the **CLEAR** button to exit or press **ENTER** to accept.

Step 3 – Return the Function dial to AUTO/RUN  position to exit Program Erase.

Program Erase – Complete Controller Reset

Activating this function will erase all data settings in the MC-E controller. The firmware will revert back to factory default settings.

Reset the Controller

Step 1 – Place the Function Dial to the Program Erase  position.

PROGRAM Erase
Enter Prog #

Step 2 – Enter **9** **7** **3** **1** and press **ENTER**.

NOTE: Press the **CLEAR** button to clear any “Key Entry Error”.

COMPLETE RESET
ARE YOU SERIOUS?



COMPLETE RESET
Reset GlobalInfo

Press the **CLEAR** button to exit or press **ENTER** to accept.

Step 3 – Return the Function dial to AUTO/RUN  position to exit Program Erase.

Station Test



The MC-E provides the Station Test to allow you to activate all stations whether they are assigned to a program or not. When a Station Test is performed, the controller will sequence through all the stations and activate them for the specified duration.

Perform Station Test

Step 1 – Place the Function Dial to the Station Test  position.

Set TEST TIME &
press MAN ON/OFF



Step 2 – Enter the station runtime from 01 second to 30 minutes (seconds must be entered with 0 first, i.e. 45 seconds, enter 045) and press the  to initiate the test.

NOTE: If no runtime is entered before pressing the  button, the controller will test each station for two minutes. Press the  button to clear any “**Key Entry Error**”.

Example: Test each station by activating them for one minute. Press the   buttons.

STATION TEST
STN 1 0m59s

Press the  button to advance to the next station if the test time per station is in minutes.

Press  and  button to advance to the next station if the selected test time per station is in seconds.

Place the Function Dial to  (RAIN OFF) position to Cancel the procedure.

Step 3 – Return the Function dial to AUTO/RUN  position to exit Station Test.





Options 1–8



To set station 1 as a normally-closed master valve and assign it to any program, Program 1 (Option 1) through Program 8 (Option 8).

Activate Option 1–8 to Activate Secondary Master Valve (Station 1)

Step 1 – Place the Function Dial to the Options  position.

```
OPTION# 1
PGM 1  Mv=Master
```

Step 2 – Use the  and  buttons to select the program to modify. Use the  and  buttons to set the Master Valve to Master or Station 1.

Example: Set Program 2 to use Station 1 as a secondary master valve. Press the  or  button until Option# 2 is displayed. Press the  or  button to toggle the Master Valve option to STN 1.

```
OPTION# 2
PGM 2  Mv=STN 1
```

Step 3 – Repeat Step 2 to modify additional programs.

Step 4 – Return the Function dial to AUTO/RUN  position to exit Options.



Options 9 (Activate Exclusive Program with Start Sensor)

Option 9 is used in conjunction with the Start Sensor and Program 8. With Option 9 set to “PGM 8 Start=ON” and the Start Sensor is activated, all automatic and manual watering will turn off and program 8 will immediately turn on. Automatic programs will be suspended until the Start Sensor is deactivated. As long as the Start Sensor is activated, Program 8 will continue to repeat its cycle.

Activate Option 9

Step 1 – Place the Function Dial to the Options  position. Press the  or  button until Option 9 is displayed.

```
OPTION# 9
PGM 8  Start=OFF
```

Step 2 – Use the  or  button to activate or deactivate Option 9. When activated, program 8 will start when the start sensor is triggered.

NOTE: If program 8 has no value, the controller will function normally.

Step 3 – Return the Function dial to AUTO/RUN  position to exit Options.

Options 10

Option 10 is used in conjunction with the Start Sensor and Program 1. With Option 10 set to “PGM 1 Start=ON” and the Start Sensor is activated, Program 1 will turn on immediately. Program 1 will repeat the cycle continuously until the start sensor is deactivated. All other programs will not be affected and will activate as scheduled.

Application Example: Activate dust control program with wind sensor, allow other programs to continue.

Activate Option 10

Step 1 – Place the Function Dial to the Options  position. Press the  or  button until Option 10 is displayed.



```
OPTION#10
PGM 1 Start=OFF
```

Step 2 – Use the  or  button to activate or deactivate Option 10. When activated, program 1 will start when the start sensor is triggered.

NOTE: If program 1 has no value, the controller will function normally.

Step 3 – Return the Function dial to AUTO/RUN  position to exit Options.

NOTE: If Option 9 is activated, it will take precedence over Option 10. (See “Option 9” on page 30.)

Options 11

Option 11 is used to activate or deactivate the master valve during station delays.

Application Example: Water well recovery between station operations where the well needs to refill from ground water. The MV/Pump circuit would be OFF during the delay period.

Activate Option 11

Step 1 – Place the Function Dial to the Options  position. Press the  or  button until Option 11 is displayed.

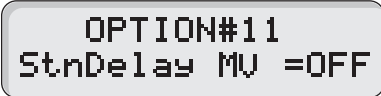

```
OPTION#11
StnDelay MV =OFF
```

Step 2 – Use the  or  button to toggle Master Valve function from ON or OFF during station delays.

Step 3 – Return the Function dial to AUTO/RUN  position to exit Options.

Rain Off



The MC-E provides Rain Off to temporarily suspend the controller's automatic watering. When Rain Off is activated, automatic watering cycles are halted until the Rain Off duration has elapsed. Rain Off can be programmed from 0 (Rain Off deactivated) to 14 days.

Activate Rain Off

Step 1 – Place the Function Dial to the Rain Off  position.

Step 2 – The MC-E will execute a 3-second countdown to cancel any active watering. In this function dial position, all automatic watering will halt until it is returned to Auto Run position.

Step 3 – You can also set a specific rain delay duration in days.

Example: Place the controller in Rain Off for three days. Enter the desired days off, in this case , and press the  button to accept.

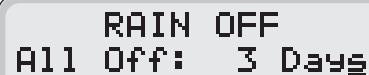

RAIN OFF
All Off: 3 Days

NOTE: **3 Days** indicate that the current day is day number 3. The controller will countdown at day change until day 0 is met. At day 0, all automatic watering is restored. Disable the Rain Off feature by entering a Rain Off value of 0 day. Press the  button to clear any “Key Entry Error”.

Step 3 – Return the Function dial to the AUTO/RUN  position to exit Rain Off.



NOTE: If station #2 is set as the normally-open master and activated (for flow sensing feature) RAIN OFF will not shut it off.







Semi-Auto Operation

The Semi-Auto operation allows you to manually activate up to six programs regardless of run times. Before starting multiple, overlapping programs, make sure your system can support the increased hydraulic demand.

Activate Semi-Auto



Step 1 – Place the Function Dial to the SET PROGRAM  position.

Step 2- Enter the program number you want to activate. Press  to accept. Press either the button for the number of the first station in the program or the number of the station within the program where you wish to start the semi-automatic run. Then press . (If you do not remember the first station in the program, pressing “1” will automatically select the program's first station for the semi-auto start.)

Example: With the Function Dial at SET PROGRAM , press  and . If station 8 is where you want Program 2's semiautomatic run to start, press  and  to start the operation. If you do not know which stations are in Program 2, just press  and . Program 2's first station will start.

Step 3 – Return the Function Dial to AUTO/RUN  position. The controller will finish the semi-auto run of the remaining stations for the selected program and then await its next automatic start time.

Step 4 – Repeat steps 1 through 3 to start other programs semi-automatically. The controller will allow the semi-automatic programs to overlap or run concurrently.

Step 5 - To turn off selected programs' semi-automatic runs, turn the dial to SET PROGRAM , enter the Program's number and then press . This will turn off only the selected program. Other semiautomatic runs are unaffected. Return the dial to AUTO/RUN .

NOTE: To turn off all ongoing operations, turn the dial to RAIN OFF. Return the dial to AUTO/RUN  to leave the controller in automatic mode.

Manual Operation

The MC-E provides True Manual operation feature for unscheduled station activation. With True Manual, the selected station will then water until you turn it off or until the controller's current time reaches midnight. As a safety precaution, the controller is programmed to halt Manual watering at midnight. When Manual is in operation, MC-E will beep every 30 seconds to indicate active operation.

Activate Station Manually

Step 1 – Place the Function Dial to the Manual  position.

Step 2 – Enter the station number you want to activate. Press the  button to activate.



NOTE: Only one station can be manually activated, multiple station activation is not allowed.

Example: Activate Station 5. Enter  and press the  button.



MANUAL MODE
STN# 5 12h30m05

IMPORTANT! The MC-E “True Manual” feature requires you to turn the operation off once activated. Otherwise, the manual operation is designed to activate until midnight. Notice that the displayed manual operation runtime will always end at midnight.

You can move the station number back or forward by pressing the  or  button.

Step 3 – Return the Function dial to AUTO/RUN  position to deactivate manual operation and place the controller back to Auto Run mode.

NOTE: Manual watering has the least priority. If a scheduled program activated the maximum available active stations, then Manual operation will not run. When the maximum allowed active stations is reached while manual operation and scheduled program are running, the Manually activated stations will deactivate to accommodate the stations in the automatic program.

Remote Control (Purchased Separately)

The MC-E is equipped with two remote control ports to be used with the Toro Sentinel™ Remote Central System and hand-held maintenance remote controls.

Maintenance Remote Controls

The MC-E can be remotely operated using any of the following remote control systems:

- KwikStart® Remote (KSR-KIT-K) Control System
- Commercial Maintenance Remote (CMR-KIT) Control System
- Eicon's Maintenance Remote Control System
- Some models of TRC Irrigation Remotes.

For Irritrol KSR-KIT-K and CMR-KIT:

Step 1 – Verify that the Function dial is in the Auto Run  position.

Step 2 – Secure the remote control system's receiver cable to the MC-E KSR/CMR remote socket. Remote system such as the KwikStart will require an adapter cable to install. Refer to the remote control system's installation and operation instructions for additional information.

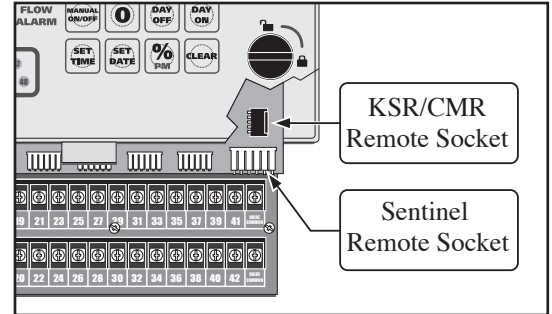

For the Toro Sentinel Remote Central System, Eicon or TRC Remotes (Sidekick or Commander):

The MC-E controller is designed to be compatible with the Toro Sentinel Remote Central System, Eicon and some of the TRC remotes.

When the function dial is placed in the Remote Control position, MC-E will immediately stop all activities and it will start receiving commands from Sentinel Central, Eicon or some of the TRC remotes. As long as the function dial is in the Remote Control position, all scheduled programs are ignored and the 5-pin KwikStart Remote (KSR)/Contractor Maintenance Remote (CMR) port is disabled. The MC-E will only operate based on commands received from Sentinel Central, Eicon or TRC remotes.

Step 1 – Secure the 6-Pin ribbon data cable from the MC Link remote device to the MC-E Sentinel remote socket.

NOTE: The other remotes utilizes the 6-pin Sentinel remote socket also.

Step 2 – Place the Function Dial to the Remote Control  position. Leave the dial at the remote control position to keep the MC-E under the control of Sentinel Central, Eicon or TRC remotes.

**Sentinel Control
Start Receiving**

Step 3 – Return the Function dial to AUTO/RUN  position to exit Sentinel's Remote Control communication.

NOTE: Any remote that uses the Sentinel remote socket bypasses the controller's diagnostic circuit breaker. Do not use this type of remote for electrical troubleshooting.

Flow Sensor (Sold Separately)

Flow monitoring is one of the best water resource management tools available in the irrigation industry today. With definable over and critical flow values, broken lateral or mainline piping, stuck valves and damaged sprinklers can be quickly detected and bypassed automatically.

The flow sensing capability of the MC-E allows it to learn actual flow rates for every station. These flow rates are stored in the memory for comparison use. Whenever a station is activated, MC-E will monitor and compare the values to detect if overflow or critical flow values have been violated. The overflow percentages are user defined to fine tune the system.

The MC-E is designed to function with a normally open master valve and a flow sensor. The Data Industrial PVC tee flow sensor model 228PV, 250BR or equivalent are the recommended sensors for use. When MC-E detects a flow value that violates the station flow parameters, the flow alert LED indicator will illuminate. The MC-E will make an audible beep every 30 seconds to notify you of the flow error. The controller will also display the problem station on the LCD.

The flow alert indicators will continue until the detected flow is returned within the set parameters and the **CLEAR** button is pressed.

NOTE: Flow sensing requires that Station 2 is used for a normally-open master valve rather than a regular station. See Optional Setup.

Flow Sensor Installation

Step 1 – Install the flow meter into the main pipe that only supplies irrigation to the area being monitored. Typically, it is installed just before or after the master valve. Install the flow sensor according to the provided instructions. Pay particular attention to the flow direction and to the length of straight pipe required before and after the flow sensor. Take note of the sensor size and the pulse rating for the MC-E flow sensor setup.

Step 2 – Route a two-wire irrigation cable from the flow sensor to the MC-E controller. The cable can be 2000 ft. in length when using a shielded two-conductor, 20 AWG or larger stranded copper wire. Leave extra wire length to allow for future servicing. Take note which wire is installed to the red sensor wire as well as the black sensor wire.

Step 3 – At the controller terminals, connect the “Red” wire to FLOW+ terminal. Connect the “Black” wire to the FLOW- or SENSOR- terminal. See illustrations.

NOTE: The controller will beep every 30 seconds when an flow error is detected.

IMPORTANT! Sensor wires must be installed in the correct polarity for proper operation. If you plan to use the controller’s flow sensing function, set flow parameter and learn the flow value for all the stations being used. MC-E will not execute the flow diagnostic if an active station is without flow settings even if other active stations have flow settings configured.

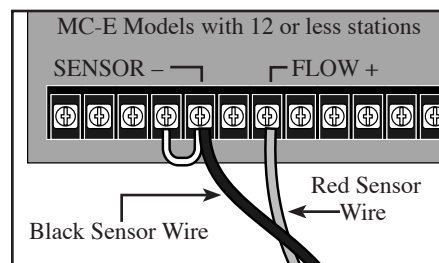
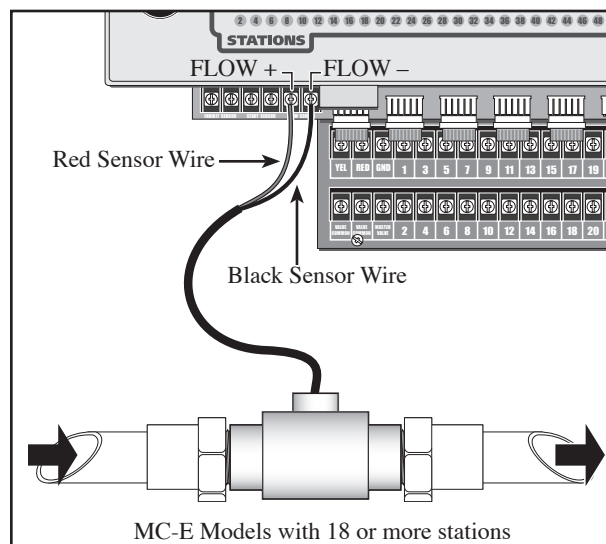

Flow Sensor Setup

Flow Sensor Overview





The flow sensing system in the MC-E is designed to reduce the risk of flood damage and water waste. As previously described, the controller requires a properly sized flow sensor in the system. Also, (connected to Station #2 which must be converted to Flow Alarm) a normally-open master valve is required.





NOTE: In the SETUP procedure all stations must be set to “MV=ON”.

The controller has an adjustable flow delay, with a default length of 1 minute, to allow the flow to “settle” after a valve opens. After each valve’s delay period, (settable from 1 to 9 minutes) the controller will monitor the sensor reading.

NOTE: Because of delay times and the length of the automatic flow diagnostic procedure, station times under 3 minutes are not recommended when using flow sensing.

The controller can “learn” the correct flow for each irrigation zone in the system. Also, the maximum acceptable flow limit for the main line can also be set. With the above in place, the MC-E can detect an overflow condition for a particular valve in operation (compared to its learned flow) and shut it off. If the controller can cure the flow problem by turning off the offending station, it will identify the station with the flow error in its display, illuminate the FLOW ALARM light on its face panel and beep once every 30 seconds to alert the user. Before moving on to the next station in the program, the controller will check flow in the main line with all valves off. If no flow, the controller moves on. If flow is detected with no stations on (catastrophic flow), in addition to the alerts above, the controller will energize and close the normally-open master valve to shut off the irrigation main line.

While the controller is in AUTO/RUN , but idle, any detected flow with no valves on will also energize station #2 for shut down. Even if you turn the controller to Rain Off , the MC-E will continue to energize station #2 to keep the normally-open master valve closed. To clear the flow alert and allow the master valve to open, turn the dial to FLOW SENSING  and press .

Use either STATION TEST  or MANUAL  to sequence through the stations or to operate a suspect station as you visually locate the cause of the over flow or unscheduled flow condition. To allow for searching and testing, flow sensing is not active in STATION TEST  or MANUAL  modes.

CAUTION: Flow sensing is active in the controller’s automatic mode for detecting overflow conditions in the remote control valves and mainline catastrophic flow. Other water outlets in the irrigation mainline will cause unscheduled flow and activate mainline shutdown. To operate quick coupler valves, etc. downstream of the flow sensor, either disable flow sensing or manually turn on an unused station that has no learned flow. During operation of a station with no learned flow, flow sensing is disabled.

NOTE: When the controller is in RAIN OFF , flow sensing is disabled.

Enable/Disable MC-E Flow Sensing

Step 1 – Place the Function dial to the FLOW SENSING  position.

Step 2 – If Flow Sensing is not Enabled, the controller will prompt “Enable Flow? Press DAYOFF”. Press the  button to activate flow sensing. The K Value/Size Code screen will be displayed when flow sensing is successfully enabled:

Step 3 – Deactivate flow sensing by pressing the  button.

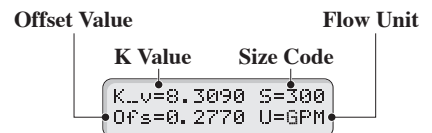

Catastrophic Flow Sensor Protection (Optional Setup)

The MC-E provides a function to detect an unscheduled flow. Any detected flow in the system when no station is watering is considered an unscheduled flow. The MC-E has the capability to monitor any unscheduled flow and activate Station 2 as a flow alarm to shut off a normally open master valve.



The flow alarm can be used to activate a normally open master valve which is installed ahead of the other valves on the system. Station 2 must be set to flow alarm in SETUP for this to function. The F00 (“F00” represents the upper flow limit for the main line) parameters in the flow setup will dictate the overflow threshold of the main line. When at any time MC-E detects an unscheduled flow that violates F00 overflow parameters, MC-E will activate station 2 to close the normally open master valve.

Install Critical Flow Shut off Master Valve

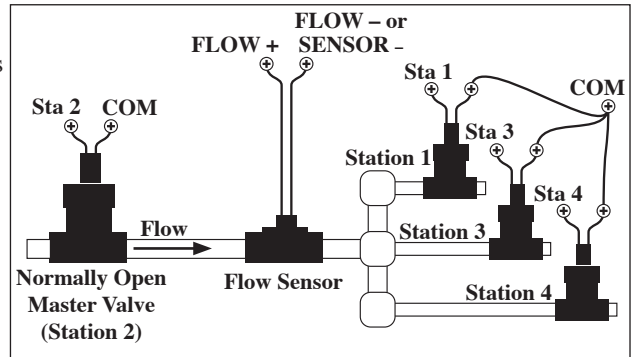



- Step 1 – Find a location along the sub-main pipe that services the irrigation system to install the normally open master valve. The location should be ahead of any valves in the irrigation system. Refer to the valves installation instructions for further details.
- Step 2 – Route a two-wire irrigation cable from the valve to the controller. Connect one solenoid wire to the valve common terminal and the remaining solenoid wire to the Station 2 terminal.
- Step 3 – Check for proper operation.



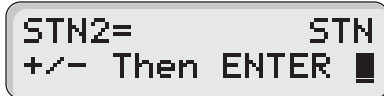



Configure Station 2 for Flow Alarm Function

- Step 1 – Place the Function dial to the SETUP  position.
- Step 2 – Press . Station 2 setup screen will be displayed.



- Step 3 – Press the  button to configure Station 2 as flow alarm to activate a normally-open master valve or press the  button to configure it back to station. Press  to activate your selection.
- Step 4 – Return the Function dial to AUTO/RUN  position.

Catastrophic Flow Parameters

- Step 1 – To assign F00's flow value (Catastrophic flow), place the Function dial to the FLOW SENSING  position. Navigate to the Over percentage limit screen by pressing the  button. If F00 is not the displayed station number, press the  button repeatedly until F00 is selected.
- Step 2 – Enter the desired catastrophic flow value and press .

NOTE: Do not set the Catastrophic flow value below the rated minimum flow of your flow sensor or it may not function properly.

For example: If your flow sensor is rated at 20–300 GPM, **DO NOT** set the F00 flow value below 20 GPM.

- Step 3 – Adjust the catastrophic Overflow. See “Set Overflow percentages” section.

Set Flow Sensor Model

Step 1 – Place the Function dial to the FLOW SENSING  position. Enable flow sensing if its disabled.

Step 2 – While in the K Value/Sensor Size screen, select the flow sensor size code by pressing the  button.

Use the Flow Sensor table below to find your specific size code.



Example: If using Sensor Model TFS-075, press the  button until the S value in the display equals 75 (S=75).

Flow Sensor Data Table

Flow Sensor Model	Size Code	Pipe Size	K Value	Offset	GPM	L/Sec
Unknown Flow Sensor	00	Unknown	1	0	PPS	PPS
TFS-050	50	1/2"	0.07800	0.9	1.2 – 12	0.1 – 0.8
TFS-075	75	3/4"	0.15630	0.9	2.7 – 28	0.2 – 1.8
TFS-100	100	1"	0.26112	1.2	5.0 – 50	0.3 – 3.2
TFS-150 or 228PV15xx-xxxx	150	1.5"	1.69900	-0.3160	5 – 100	0.3 – 6.3
TFS-200 or 228PV20xx-xxxx	200	2.0"	2.84290	0.14350	10 – 200	0.6 – 12.6
TFS-300 or 228PV30xx-xxxx	300	3.0"	8.30900	0.22700	20 – 300	1.3 – 18.9
TFS-400 or 228PV40xx-xxxx	400	4.0"	13.74283	0.23707	40 – 500	2.5 – 31.5
250BR0700x-xxxx	7	3/4"	0.43680	0.56800		
250BR1000x-xxxx	10	1"	0.39740	0.26180		
0.25 Liters Per Pulse	11	0.25 L/P	1	0		
0.50 Liters Per Pulse	12	0.50 L/P	1	0		
1 Liter Per Pulse	13	1 L/P	1	0		
2.5 Liters Per Pulse	14	2.5 L/P	1	0		
5 Liters Per Pulse	15	5 L/P	1	0		
10 Liters Per Pulse	16	10 L/P	1	0		
25 Liters Per Pulse	17	25 L/P	1	0		
50 Liters Per Pulse	18	50 L/P	1	0		
100 Liters Per Pulse	19	100 L/P	1	0		
250 Liters Per Pulse	20	250 L/P	1	0		
500 Liters Per Pulse	21	500 L/P	1	0		
1000 Liters Per Pulse	22	1000 L/P	1	0		

Set Flow Unit

Step 1 – Place the Function dial to the FLOW SENSING  position. Enable flow sensing if its disabled.

Step 2 – Press the  button to change the flow unit. Press the  button repeatedly until the desired flow unit is displayed (GPM = Gallons per Minute, CFM = Cubic Feet per Minute, CMH = Cubic Meter per Hour, LPM = Liter per Minute or PPS = Pulses per Second).

NOTE – If the sensor you choose is not represented on the chart, use “Unknown Flow Sensor” size code “00”. The flow unit for “Unknown Flow Sensor” can only be set to PPS.

Read/Learn Station Flow Value

Step 1 – Place the Function dial to the FLOW SENSING  position. Enable flow sensing if its disabled.

Step 2 – Verify that all flow parameters are set, then press the  button to read/learn each of the station’s actual flow. It will read/learn the station’s flow value until the flow delay time expires. The default flow delay is one minute. During “Learn Flow” each station will be displayed with the flow that the sensor is measuring.



To learn the flow value of a specific station, enter the two digit station number and press the  button.

To learn the flow value of a group of stations, enter the two digit station number of the 1st station, the two digit station number of the last station and press the  button. The MC-E will sequentially read the flow value for each station in the group.

Step 6 – To review each station flow parameters, press the  button. MC-E will sequentially display each of the station’s flow parameters.

Set Overflow percentages

Step 1 – Place the Function dial to the FLOW SENSING  position. Enable flow sensing if its disabled.

Step 2 – Select the station number being edited. While in the K Value/Size Code screen, press the  button to advance to the Overflow screen. Press the  button to advance the Station number.

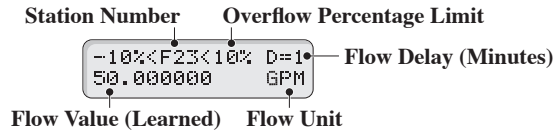

Step 3 – Press the  button to adjust the Overflow percentage. This value will set the maximum flow value limit.



When actual flow reads above the maximum, the flow alarm LED will activate and an audible tone will beep every 30 seconds. MC-E will also flash in the display which station posted a faulty flow reading.

NOTE: The factory default Overflow percentage is 40%. Underflow is not monitored.

Set Flow Delay Time

Step 1 – Place the Function dial to the FLOW SENSING  position. Enable flow sensing if its disabled.



Step 2 – Press the  button to advance the display to the Underflow/Overflow screen.

Step 3 – Press the  button to adjust the flow delay time. The flow delay time is the period that MC-E will wait after activating a particular station before reading the flow. This delay period allows the irrigation system to normalize to get an accurate flow reading. The default flow delay time is set at 1 minute but can be adjusted up to 9 minutes using .

Step 4 – Press the  button to advance to the next station number and adjust the remaining station's flow delay.



 **IMPORTANT!** Station 2 is no longer a regular station. Leave its settings at 0.

Clear Flow Alarms:

Press the  button. Use the procedure below if pressing the  button did not clear the alarms.

Temporarily Clear Flow Alarm

Step 1 – To temporarily clear the flow alarm, disable the flow function by placing the function dial to the FLOW SENSING  position

Step 2 – Press the  button to deactivate flow. Press the  button to reactivate. By deactivating and activating the flow sensing, it will temporarily stop the flow error beeps and flashing message but MC-E will still retain in memory which station incurred a flow error. Once that station is reactivated, the flow alarm indicators will reactivate to remind you that an error occurred.

Permanently Clear Flow Alarm

To permanently clear the flow alarm, simply reactivate the station that returned the flow error.

See “Semi-Auto Operation – Activate Station Manually” for manual station activation. Once MC-E approves that the station's flow value is acceptable, the flow alarm is cleared. If the flow problem has not been resolved, the flow error will return.

Specifications

Cabinet Dimensions:

Small Metal Cabinet Unit: (9.71" H) x (10.68" W) x (4.25" D) [(24.66 cm H) x (27.13 cm W) x (10.79 cm D)]

Large Metal Cabinet Unit: (12.37" H) x (14.32" W) x (4.75" D) [(31.42 cm H) x (36.37 cm W) x (12.06 cm D)]

Input Voltage:

Domestic: 115 VAC, 50/60 Hz; Secondary - 24 VAC, 50/60 Hz, 50VA Class 2 Transformer, UL and CSA Listed.

Export: 250 VAC, 50/60 Hz; Secondary - 24 VAC, 50/60 Hz, 50VA Class 2 Transformer, CE and TUV Listed.

Output Voltage:

Station Output Voltage: 24 VAC with 1.00 Amp Max

Maximum Master Valve Current: 1.00 Amp

Total Output Current to Valves: Not to Exceed 1.68 Amps including Master Valve/Pump Start

Storage Temperature:

4° F to 140° F (-20° C to 60° C)

Operating Temperature:

32° F to 160° F (0° C to 60° C)

Humidity:

95% RH, Non Condensing, @ 100° F (37.8° C)

Electromagnetic Compatibility



Radio complies with FCC Part 22 and Part 90 of the FCC Rules

Domestic: This equipment has been tested and found to comply with the limits for a FCC Class A digital device, pursuant to part 15 of the FCC Rules. These limits are designed to provide reasonable protection against harmful interference when the equipment is operated in a commercial environment. The equipment generates, uses, and can radiate radio frequency energy and, if not installed and used in accordance with the instruction manual, may cause harmful interference to the radio communications. Operation in a residential area is likely to cause harmful interference in which case the user will be required to correct the interference at his own expense.

For Product Inquiries:

U.S.A.

P.O. Box 489

Riverside, California 92502

Tel: (909) 785-3623

(800) 634-8873

Europa

Irritrol Europe s.p.a.

Via dell'Artigianato, 1/3-Loc

Prato della Corta

00065 Fiano Romano (Roma),

Italia

Tel: (39) 0765 455201

Australia

Irritrol PTY Ltd.

53 Howards Road

Beverly, SA 5009

Tel: (08) 8300 3633